

BENCH 11221.13

INSTALLATION INSTRUCTIONS

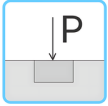

1. For maximum installation durability provide a solid surface or footing.

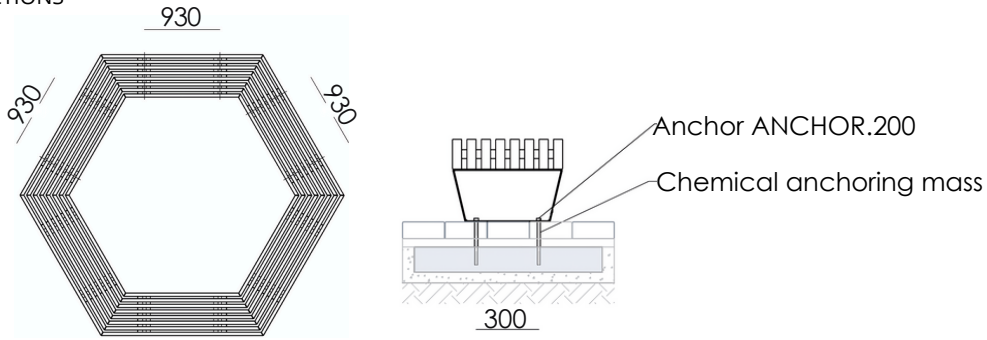

2. Place the bench in the desired place and mark the anchoring spots on the ground.



3. Drill a D=12 mm and 200+ mm deep hole for ANCHOR.200.



4. Inject chemical anchoring mass HILTI HIT-ICE or similar according to the producer's instructions.

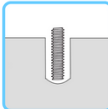

5. Insert threaded anchor ANCHOR.200 and wait till it hardens. Consult the producer for the hardening time.



6. Secure the bench to the ground with screws included in a set with the ANCHOR.200.

ANCHOR.200 is used if the existing paved surface doesn't provide sufficient support. In this case, a load-bearing footing, typically comprised of prefabricated concrete block/-s or poured-in concrete, has to be installed. The threaded part of ANCHOR.200 is anchored in the foot, thus providing secure and load-bearing support.

A set of ANCHOR.200 includes:

- Threaded rod with inner thread M8x30mm, L=200 mm – 4 pcs.



- Stainless steel bolt M8x30mm A2 DIN7991 or DIN7380 – 4 pcs.



The Installation Manual has a suggestive character, with specific materials chosen by the construction executor. All measurements are approximate and are provided for informational purposes only. This Installation Manual remains subject to possible changes.